

CONTROLLER-IPC-W-M-I5-12-4G-..

High-performance industrial controller for versatile automation applications



Industrial controller with Intel i5-1235U, 4GB DDR4 RAM, M.2 SSD (128GB, 256GB, 512GB, 1TB), 6x USB, 4x RS232, 2x LAN, 12–36V input, 12-pole terminal for flexible industrial use.

This industrial product is designed for use in a wide range of environments. It offers numerous interfaces and expansion options, allowing integration of various external devices. With support for a wide input voltage range of 12–36V, the device is highly versatile. Its robust aluminum alloy, fanless design, and compact form factor ensure reliability and low power consumption. The controller is ideal for industrial control, military applications, communications, energy supply, and network automation.

Variants:

Product	SKU
CONTROLLER-IPC-W-M-I5-12-4G-128G	SA-IPC-W-M-I5-12-4G-128G
CONTROLLER-IPC-W-M-I5-12-4G-256G	SA-IPC-W-M-I5-12-4G-256G
CONTROLLER-IPC-W-M-I5-12-4G-512G	SA-IPC-W-M-I5-12-4G-512G
CONTROLLER-IPC-W-M-I5-12-4G-1T	SA-IPC-W-M-I5-12-4G-1T

Nomenclature:

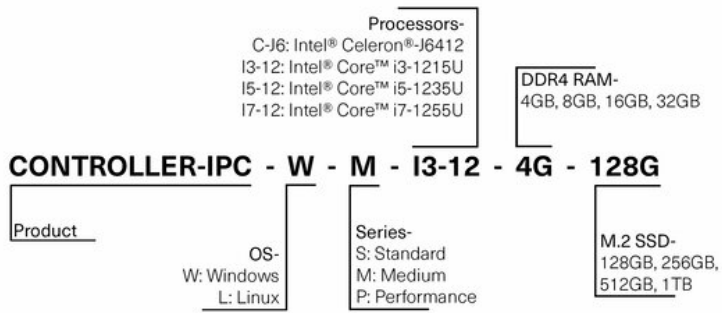

ORDER DETAILS

Function: Data acquisition, process control, machine automation, real-time monitoring, serial communication, network connectivity, flexible power supply, digital/analog I/O control.

SKU/Order No.: SA-IPC-W-M-I5-12-4G-..



Mechanical Dimensions

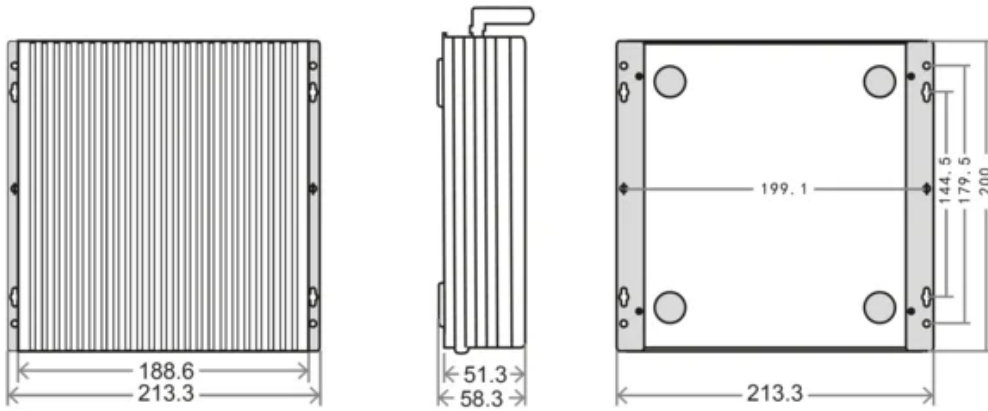

Drawings

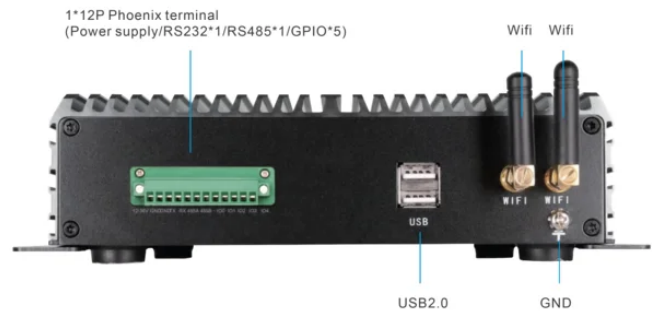
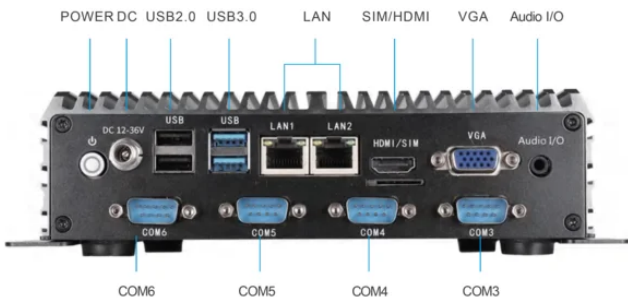

Desktop installation



Rack-mounted

Technical Data

Ambient Condition

Ambient Temperature (operating)	-10 °C ... 60 °C
Ambient Temperature (storage/transport)	-20 °C ... 70 °C
Operating Humidity (non-condensing)	95 % non condensing
Vibration	IEC 60068-2-64, random, 5 ... 500 Hz, 1 hr/axis
Impact / Shock	IEC 60068-2-27, half sine wave, duration 11 ms

Certification

Certification	CE / FCC / CB / ROHS / CCC
---------------	----------------------------

Commercial Data

Customs Tariff Number	85371091
-----------------------	----------

Dimensions

Depth (mm)	199.5
Height (mm)	58.5
Width (mm)	213.1

Interface

LAN Ports	2 x RJ45 (10 M / 100 M / 1000 M)
Serial Ports	4 x COM (default: RS232, optional: RS485)
USB Ports	4 x USB 2.0, 2 x USB 3.0
Power Connector	1*Threaded DC port (Diameter: 5.5*2.5mm)
HDMI	1 x HDMI, Supporting HDMI data output, up to 4K
VGA	1 x VGA
Audio Interface	1 x Audio I/O, onboard Realtek ALC662 HD
Wi-Fi	Support 2.4G / 5G dual-band Wi-Fi

Bluetooth	Bluetooth 4.0 (optional)
Phoenix Terminal	12-pole screw terminal block (Power supply/1xRS232/1xRS485/5xGPIO)

Mechanical Data

Weight (typ.)	1.9 kg
Cooling Method	passiv
Housing	Aluminum alloy
Mounting method	Support desktop and rack installation

System Hardware

Memory	4 GB DDR4 RAM
OS Support	WIN11, Ubuntu20.04/22.04/Redhat8.7/Debian12.2/Linux-Mint
Processor	Intel Core i5-1235U, 1.3GHz, Up to 4.4 GHz
Storage	M.2 SSD (128GB, 256GB, 512GB, 1TB)
Graphics Engine	Intel Iris Xe Graphics 80
Audio Chip	Onboard Realtek ALC662 HD audio decoding controller
SIM Card Slot	Yes

Input Data

Nominal Operating Voltage	12 V ... 36 V
Power Consumption (max.)	55 W